







20 710 882



- Ausladung 135 mm
- schwenkbarer Auslauf 360°
- runder luftangereicherter Strahl
- Armaturenhöhe 270 mm
- Höhe bis Luftsprudler 161 mm
- Bohrungsdurchmesser Seitenventil 32 mm
- Bohrungsdurchmesser Auslauf 35 mm
- Rosette Ø 55 mm
- 2x Druckschlauch M 10 x 1 eingeschraubt, dichtheitsgeprüft
- Durchfluss max. 7 l/min
- bleifrei
- Dieses Produkt leistet einen Beitrag zur Erfüllung der Vorgaben von nachhaltigen Gebäudezertifizierungen, z.B. LEED®, BREEAM®, DGNB

Nur für Becken mit Überlauf geeignet.

	Platin gebürstet	20 710 882-06
	Chrom	20 710 882-00
	Platin	20 710 882-08
	Dark Chrome	20 710 882-19
	Messing gebürstet (23kt Gold)	20 710 882-28
	Schwarz matt	20 710 882-33
	Champagne gebürstet (22kt Gold)	20 710 882-46
	Champagne (22kt Gold)	20 710 882-47
	Chrom gebürstet	20 710 882-93
	Dark Platin gebürstet	20 710 882-99

Empfohlenes Zubehör



Druckschläuche -

- 2x Druckschlauch 3/8" x 1/2" x 500 mm

12 506 970 90

20 710 882

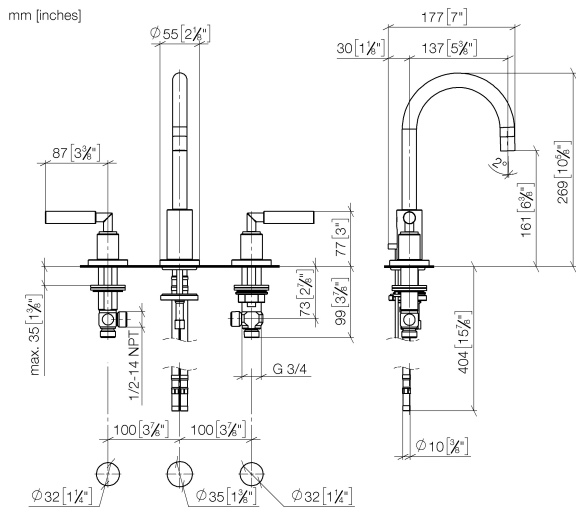

Durchflussdiagramm



Zertifikate

LGA_18925.

ETA_18514.

WRAS_2212026.

ACS_20 ACC LY 736. GDV_0400289.

20 710 882

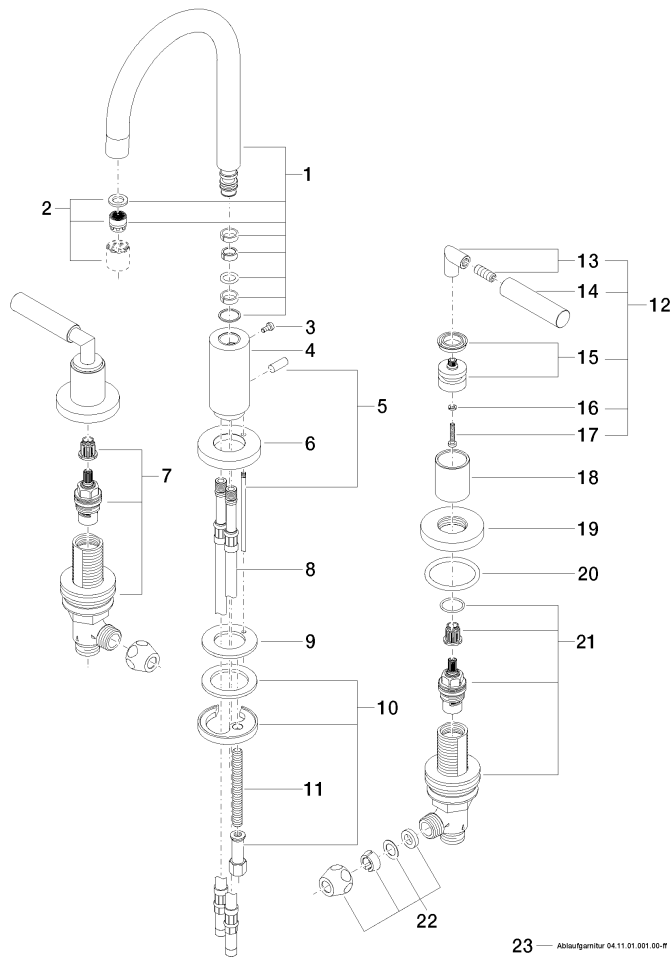

23 — Ablaufgarnitur 04.11.01.001.00-m